

Step 1: Color and cut out the shapes.

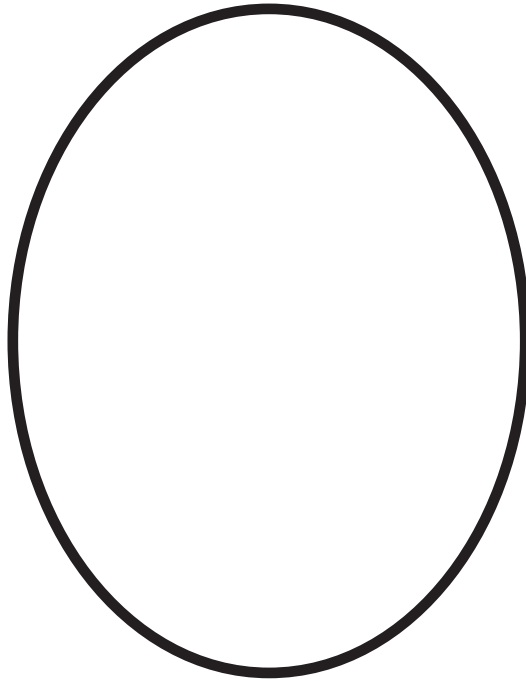

Head

Draw your own.

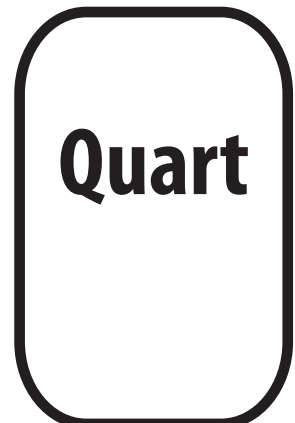
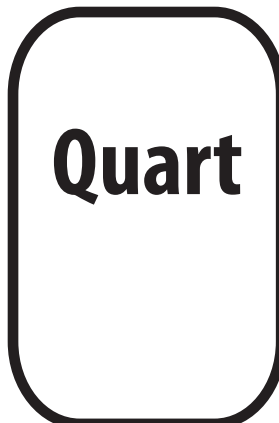
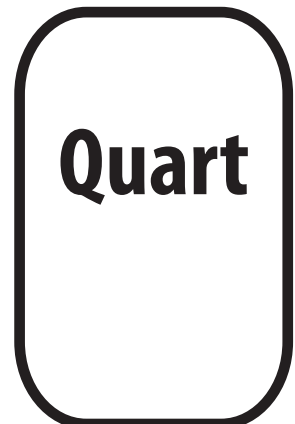
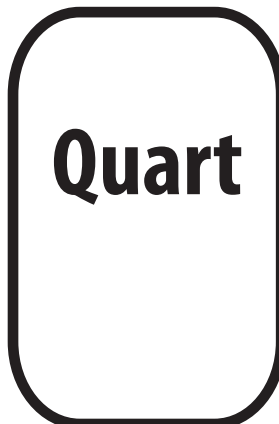
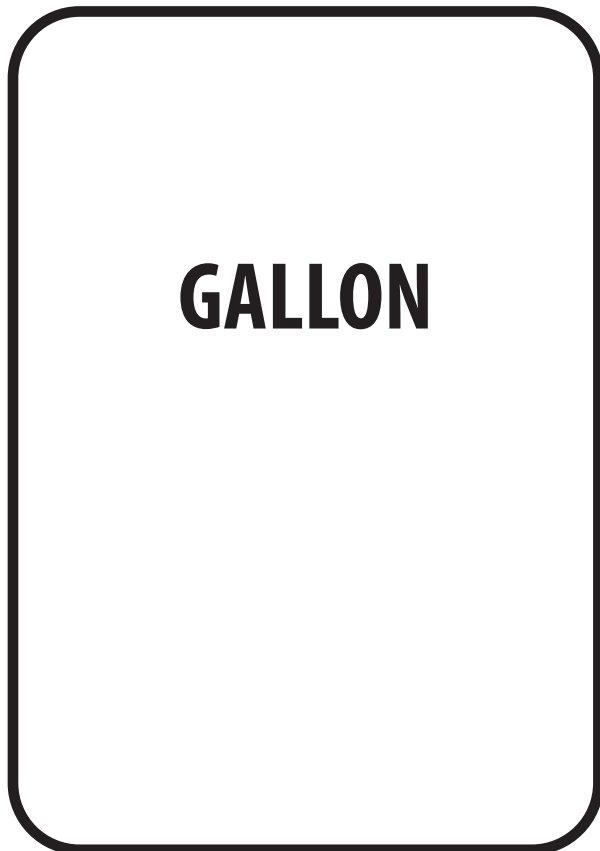

Step 2: Color and cut out the shapes.

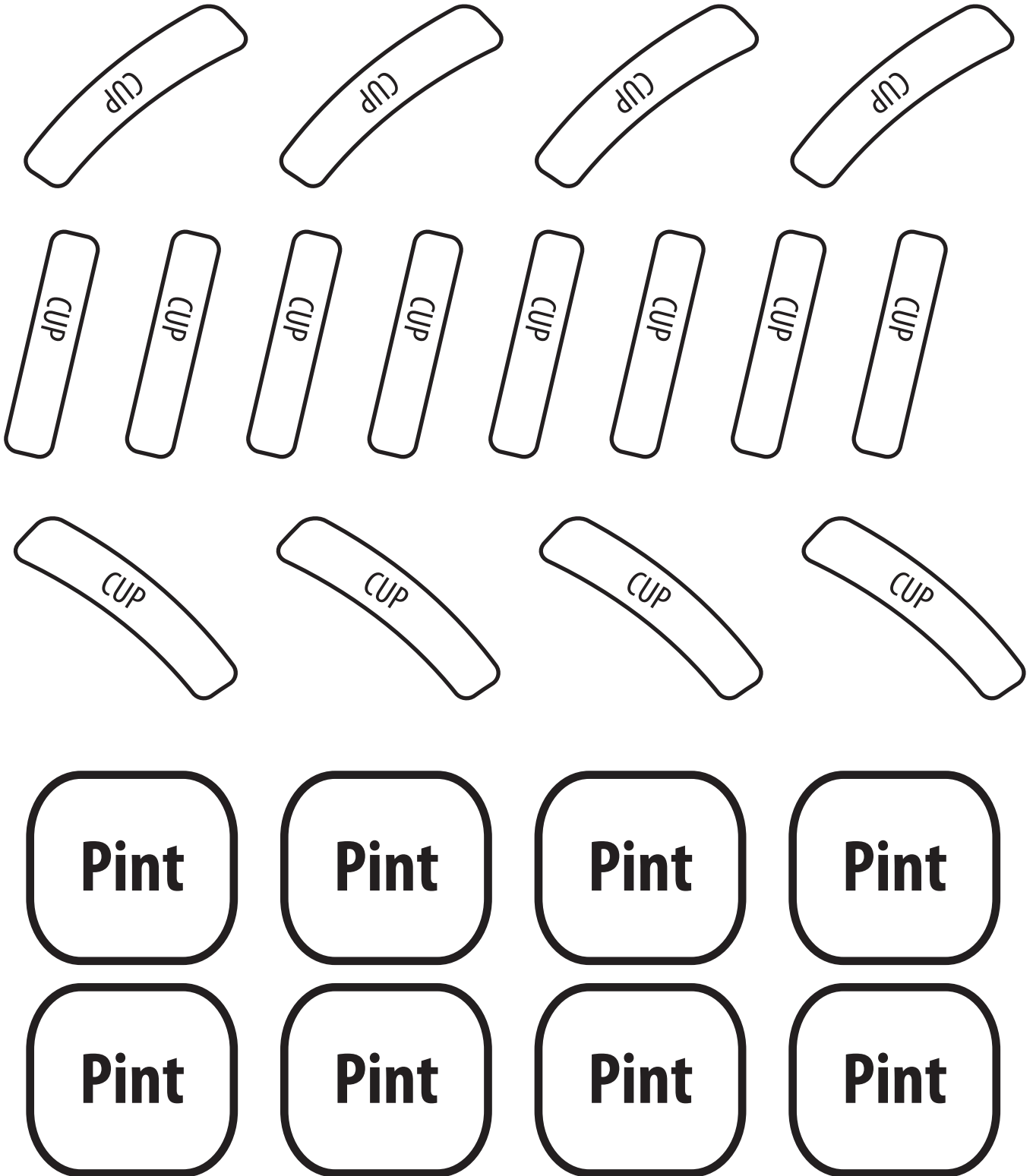

Step 3: Glue the colored and cut-out gallon shape to Gallon Man's body.

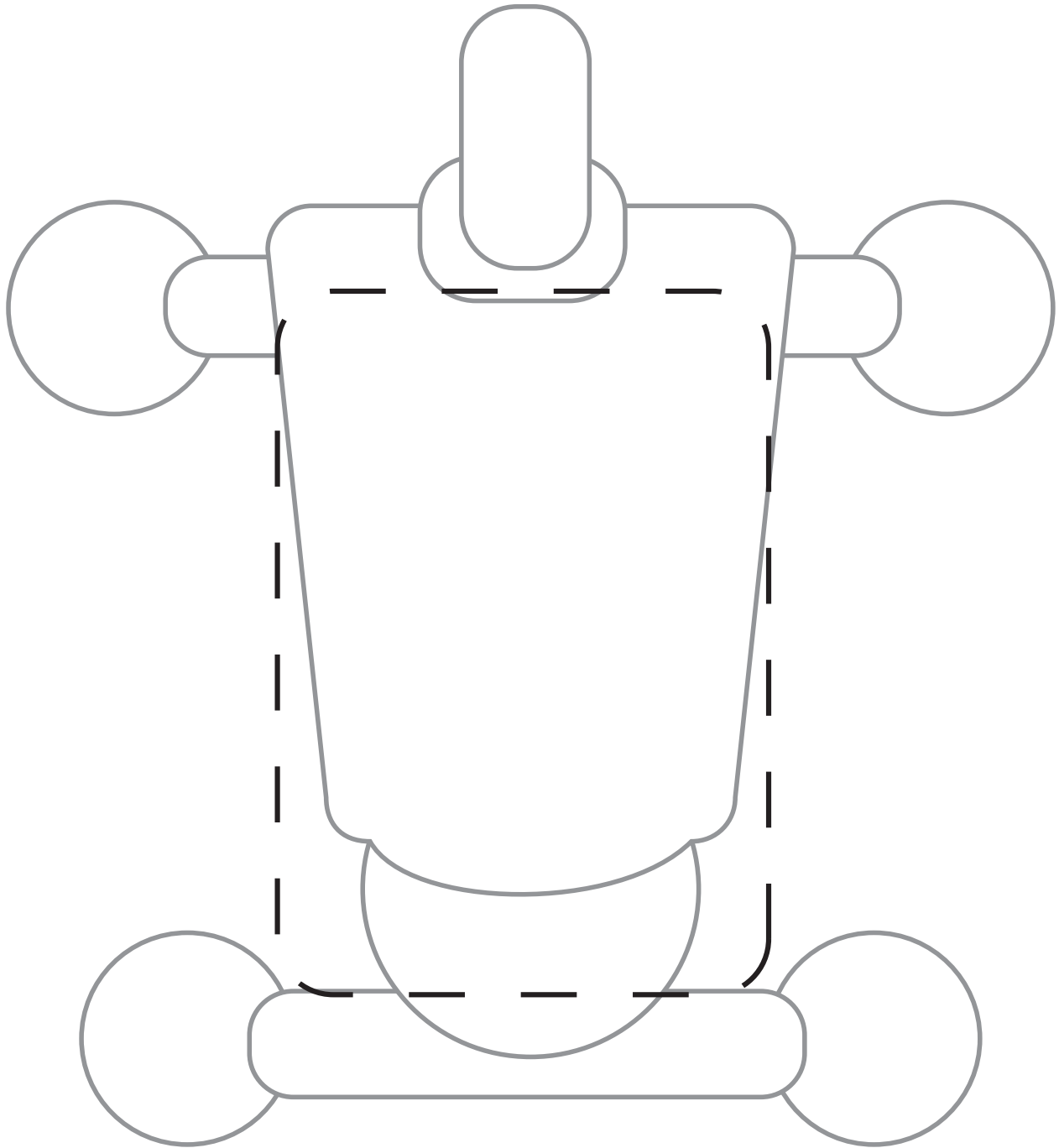

Step 4: Glue the colored and cut-out quart, pint and cup shapes to Gallon Man's two arms and two legs.

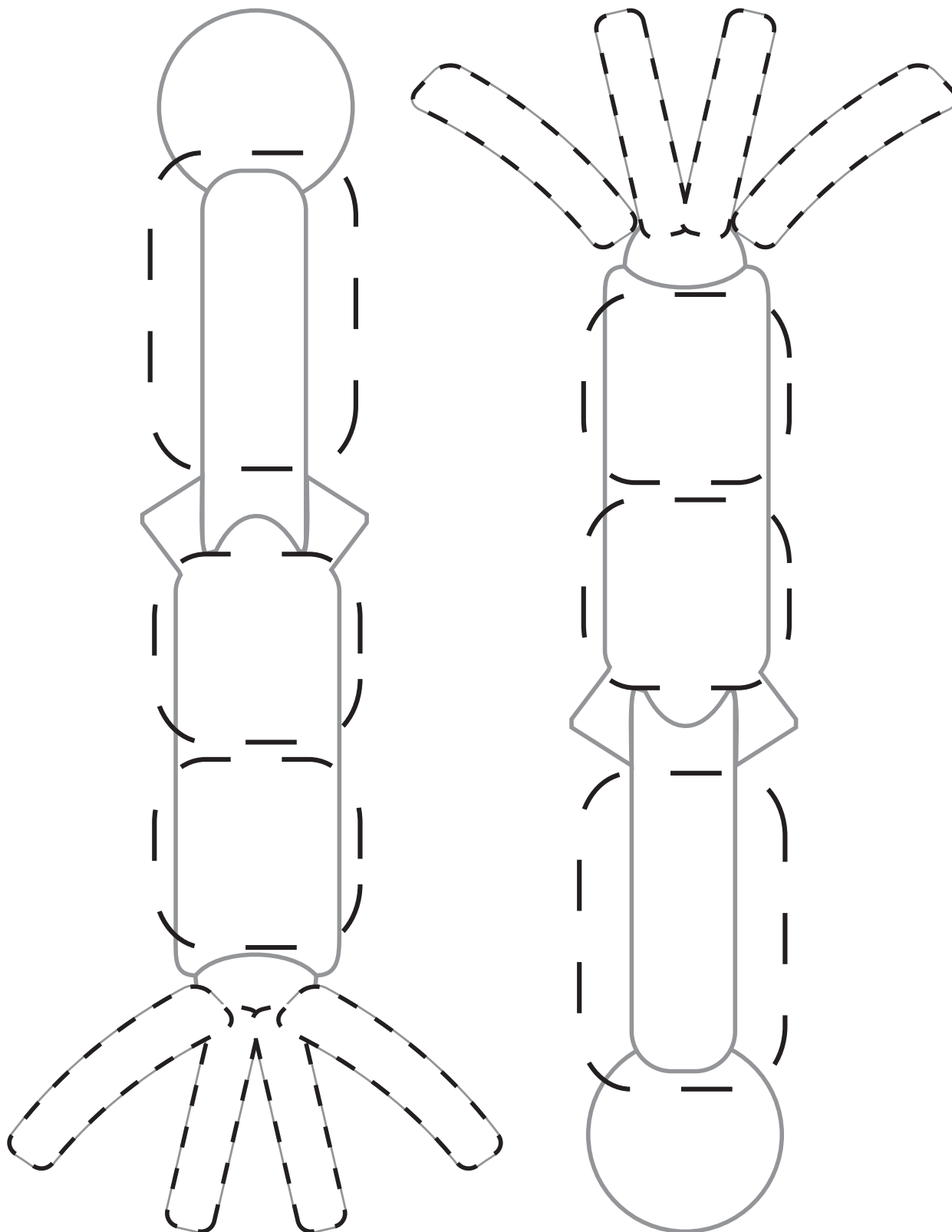

Step 4: Glue the colored and cut-out quart, pint and cup shapes to Gallon Man's two arms and two legs.

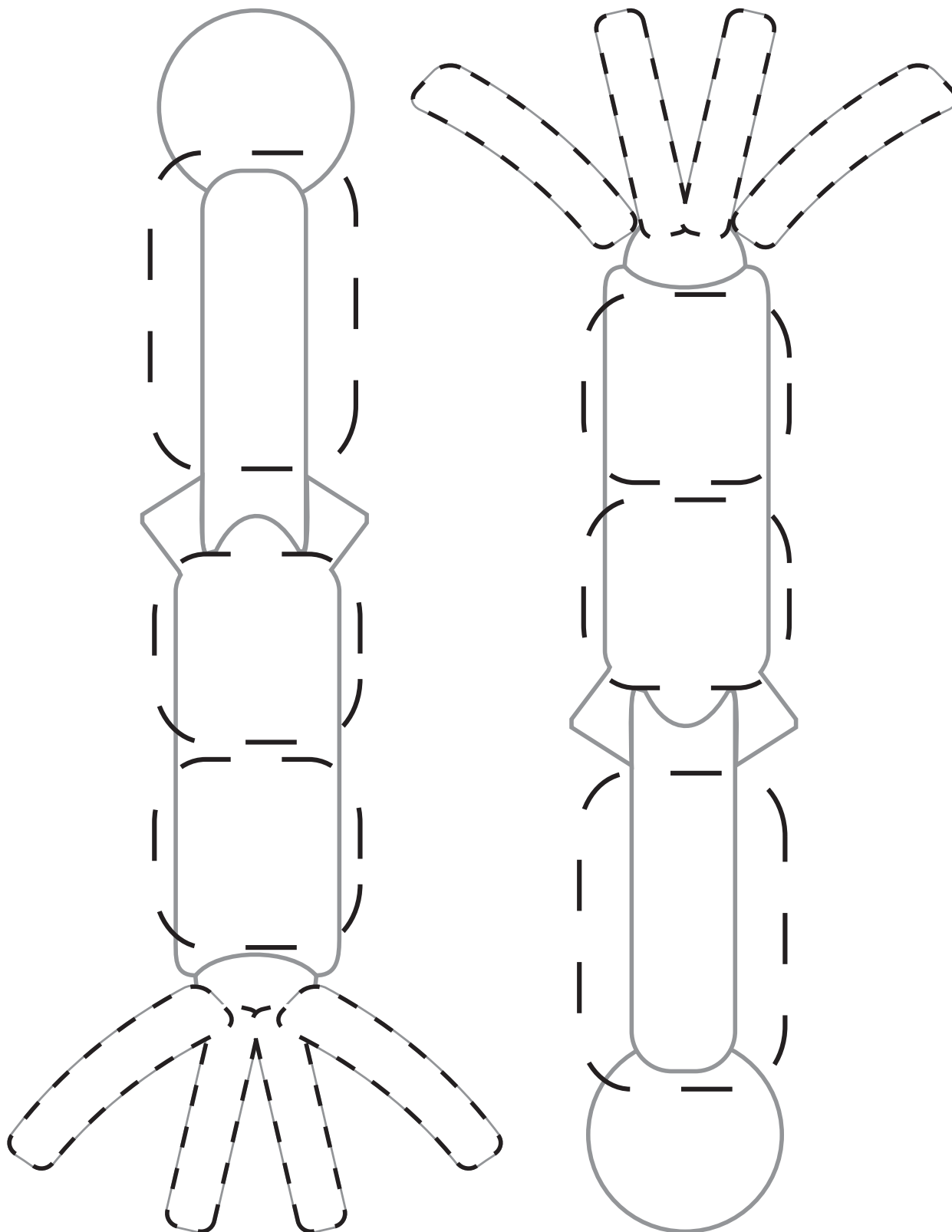

Step 5: Gather Gallon Man's body, head, two arms and two legs. Assemble all the parts on a large piece of paper that is approximately 18 inches wide and 21 inches long. Here is how the completed Gallon Man looks.

